



Sheer
driving pleasure



THE 2

GRAN COUPÉ

THE NEW BMW 2 SERIES GRAN COUPÉ.



20 Highlights



22 Worlds of colour



24 Wheels and tyres / Original BMW Accessories



YOUR NEW SPEED DATING APP.

DOWNLOAD NOW THE BMW BROCHURES APP FROM YOUR APP STORE AND DISCOVER DRIVING PLEASURE!

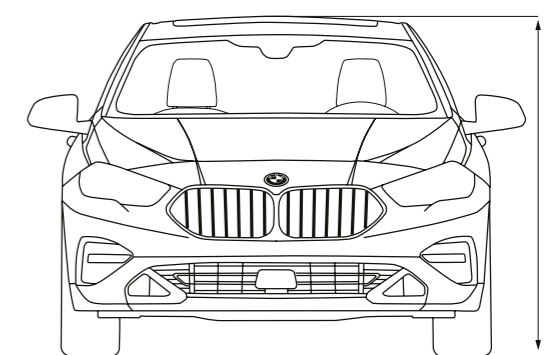

26 Technical data

**DOUBT? LONG
SINCE OVERTAKEN.**





A REAR LIKE
E THAT REQ
UIRES CONF
IDENCE.

DRIVING WITH
STYLE INSTEAD
OF DRIVING
STYLE.





YOUR PARENTS CAN DRIVE SOMETHING ELSE.

**NOTHING
IS THE WAY Y
OU KNOW IT.**







THERE'S NO SECOND CHANCE FOR A BLATANT IMPRESSION.

**GROW UP?
LEAVE THAT TO OTHERS.**



Not only makes sense in daily life – but is also fun. The new BMW 2 Series Gran Coupé.
Thrilling driving dynamics BMW M235i xDrive II M Sport suspension^{1,2,*} II M Sport brake^{1,2,*} II M Sport steering^{1,2,*} II Steptronic Sport transmission^{1,2,*}. **Sporty, elegant and compact exterior design** Large kidney grille designed as a connected element II Adaptive LED headlights¹ II Dynamic, flowing coupé line II Frameless doors II 19" wheels¹ II Broad stance, flat rear. **Timelessly stylish interior design with clear driver orientation** M Sport seats^{1,3,*} II Optimum combination of everyday practicality and sportiness II Rear seat backrest, foldable and dividable by 40:20:40 II Extensive luggage compartment volume II Panorama glass roof¹ and backlit interior trim finishers¹. **Innovative driver assistance and connectivity** BMW Intelligent Personal Assistant^{1,*} II BMW Digital Key^{1,4,*} II BMW Live Cockpit Professional with display network¹ II BMW Head-Up Display^{1,5,*} II Driving Assistant^{1,6,*} II Parking Assistant incl. Reversing Assistant¹. **Variety in all its facets – the new BMW 2 Series Gran Coupé.**

¹ Available as optional equipment. ² Standard for M235i xDrive. ³ Only available in conjunction with M Sport package and M235i xDrive. ⁴ Prerequisite is a BMW ConnectedDrive account and a compatible smartphone with Android operating system, NFC technology and integrated secure element. Only compatible with selected Android smartphones with Android 8.0 or higher. For customers with non-compatible smartphones, a high-quality key card is provided. ⁵ The information in the BMW Head-Up Display is not fully visible when viewed through polarised sunglasses. Content shown will depend on the equipment options chosen. Further optional equipment is required to display specific items. ⁶ Function may be limited in darkness or in fog. * The availability of some equipment features and functions depends on engine variants or additional options. The market and production availability may vary. You can find detailed information about terms, standard and optional equipment at www.bmw.com or at your BMW Partner.

HIGHLIGHTS.

Discover even more with the new BMW brochures app. Available now, for your smartphone and tablet.

■ Standard equipment □ Optional equipment



□ The Adaptive LED headlights contain low-beam and high-beam light including the dazzle-free high-beam assistant BMW Selective Beam as well as direction indicators in full LED technology. The equipment also features cornering lights, daytime running lights and Adaptive headlights with city, country and motorway mode for excellent illumination of the road ahead.



□ The M sports seats with integrated headrests, deep sitting surface and high side and backrest bolsters offer the driver and front passenger⁴ * improved support, even in fast turns. In addition, the seat can be adjusted to your individual body size thanks to the integrated backrest width adjustment.



□ When open, the Panorama glass roof provides a great deal of fresh air. Closed, it creates a bright, light-flooded atmosphere in the interior. It opens and closes completely automatically at the push of a button or with the vehicle key and is equipped with slide and lift functions, a roller sunblind and wind deflector.



□ Your car key? No need for that anymore. The Digital Key¹ * exists on your Android smartphone, and you can share it with friends.



□ The 8-speed Steptronic Sport transmission² * offers incredibly sporty gear changes. Whether automatic or manual using gearshift paddles or gear lever.



□ The outstanding Harman Kardon surround sound system features a 464W digital amplifier, nine channels and 16 speakers. Its extremely harmonious sound perfectly fills the interior space. Fully automatic, speed-dependent equalising precisely compensates for any background driving noise.



■ The Through-loading system with rear seat backrests, which are divisible in a 40:20:40 ratio, guarantees flexibility when transporting people and objects.



□ Interior and driver-side exterior mirrors with automatic anti-dazzle function, including electric fold-in function for the exterior mirrors and automatic curb parking function for the front passenger exterior mirror.



□ The BMW Live Cockpit Professional with navigation function includes two high-quality displays consisting of a high-resolution 10.25" Control Display that can be operated by touch and a fully digital 10.25" instrument display. The BMW Operating System 7.0 can also be operated via the iDrive Touch Controller.



□ The safety package Driving Assistant³ * includes the camera-based systems front collision warning with braking function, Speed Limit Assist incl. Speed Limit Info with No-overtaking indicator with preview and Lane Departure Warning. Additionally, the radar-based equipment includes Crossing traffic warning rear, Lane Change Warning and Rear collision warning.



□ Parking Assistant makes parking the vehicle easier. The Rear View camera provides a clearer view behind the vehicle. Active Park Distance Control offers increased protection against damage caused by parking. Parking Assistant parks the vehicle automatically, parallel or perpendicular to the street, and leaves parallel parking spaces.⁵ The Reversing Assistant supports you when reversing, e.g. in narrow lanes.

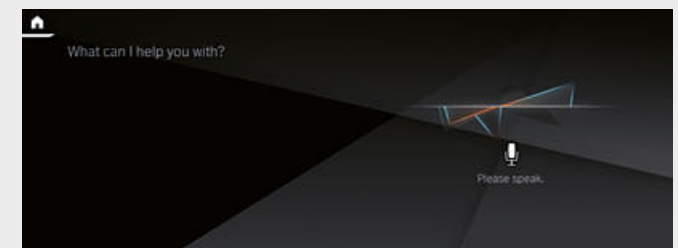

□ "Hey BMW. Who are you?" Wouldn't it be incredible if your BMW was also your personal assistant? Communicate with your vehicle using the BMW Intelligent Personal Assistant*. It knows you, gets better every day and helps out whatever the situation. You can assign your own personal activation word. It can explain everything about your car and helps you to get to know your BMW even better.

¹ Prerequisite is a BMW ConnectedDrive account and a compatible smartphone with Android operating system, NFC technology and integrated secure element. Only compatible with selected Android smartphones with Android 8.0 or higher. For customers with non-compatible smartphones, a high-quality key card is provided.

² Standard for M235i xDrive.

³ Function may be limited in darkness, fog or bright glare.

⁴ Only available in conjunction with M Sport package and M235i xDrive.

⁵ The driver is responsible for constantly monitoring the automated parking procedure in accordance with local road laws.

* The availability of some equipment features and functions depends on engine variants or additional options. The market and production availability may vary. You can find detailed information about terms, standard and optional equipment at www.bmw.com or from your BMW Partner.

EXTERIOR COLOUR WORLD.

Discover even more with the new BMW brochures app. Available now, for your smartphone and tablet.

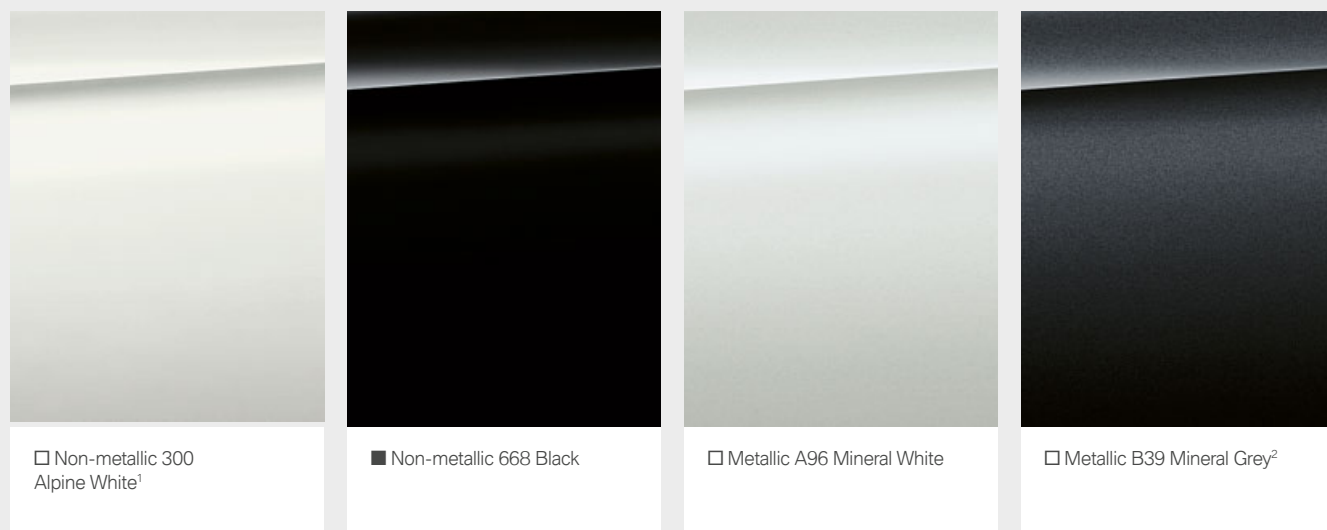

Non-metallic 300 Alpine White¹

Non-metallic 668 Black

Metallic A96 Mineral White

Metallic B39 Mineral Grey²

M Sport package

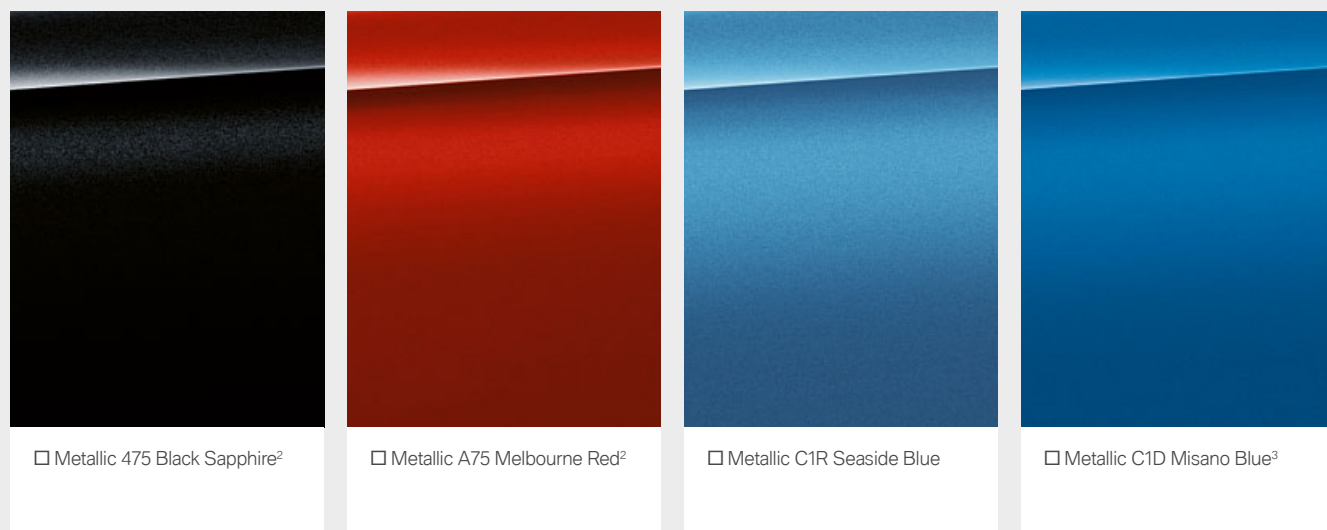

Metallic 475 Black Sapphire²

Metallic A75 Melbourne Red²

Metallic C1R Seaside Blue

Metallic C1D Misano Blue³

BMW INDIVIDUAL

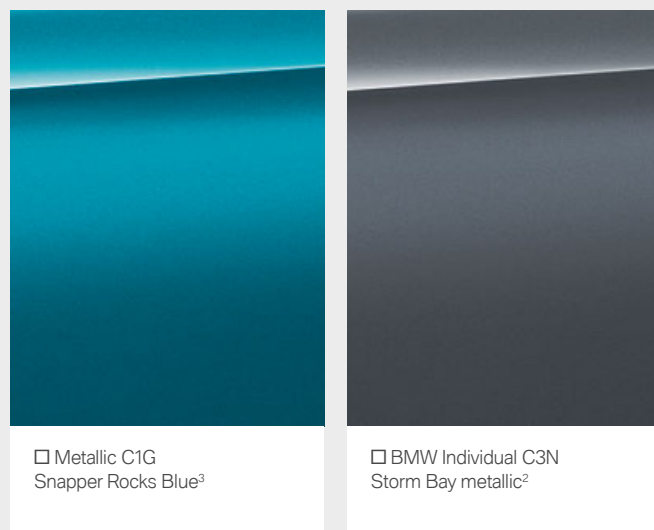

Metallic C1G Snapper Rocks Blue³

BMW Individual C3N Storm Bay metallic²

[Colour samples] These colour samples are intended as an initial guide to the colours and materials available for your BMW. However, experience has shown that printed versions of paint, upholstery and interior trim colours cannot in all cases faithfully reproduce the appearance of the original colour. Please discuss your preferred colour choices with your BMW partner or in your dealership. There you can also see original samples and be assisted with special requests.

information about terms, standard and optional equipment at www.bmw.com or from your BMW Partner.

INTERIOR COLOURS.

Equipment 22 | 23

Standard equipment Optional equipment

CLOTH

Available with

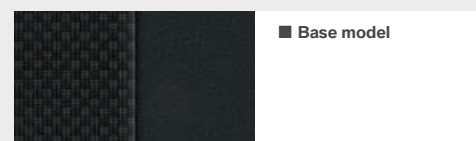

Base model

Cloth 'Grid' EGAT Anthracite

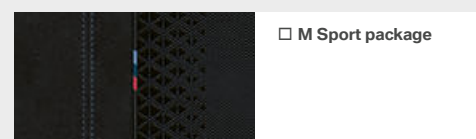

M Sport package

Cloth 'Trigon' HLSW Alcantara Black with blue highlights*

SENSATEC

Available with

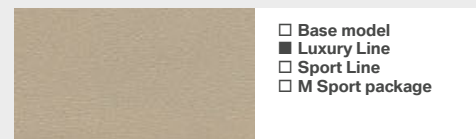

Base model
 Luxury Line
 Sport Line
 M Sport package

Sensatec KCCX Oyster*

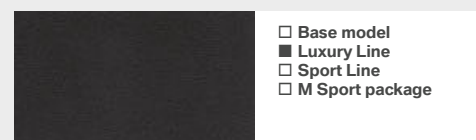

Base model
 Luxury Line
 Sport Line
 M Sport package

Sensatec KCSW Black*

CLOTH-SENSATEC COMBINATION

Available with

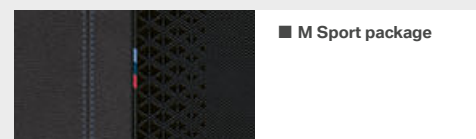

M Sport package

Cloth 'Trigon' KKSX Sensatec Black⁴

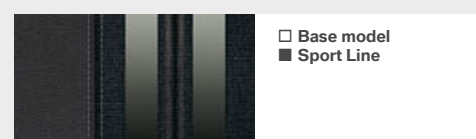

Base model
 Sport Line

Cloth/Sensatec combination KFL1 Anthracite, accent Grey*

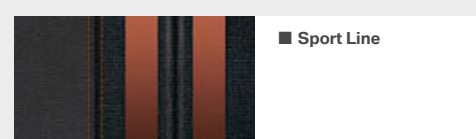

Sport Line

Cloth/Sensatec combination KFIX Anthracite, accent Orange

BMW INDIVIDUAL HEADLINER

Available with

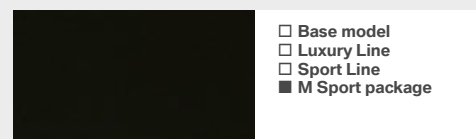

Base model
 Luxury Line
 Sport Line
 M Sport package

BMW Individual headliner 775 Anthracite*

LEATHER

Available with

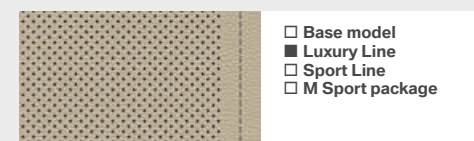

Base model
 Luxury Line
 Sport Line
 M Sport package

Leather 'Dakota' PDOA with perforations Oyster and Grey highlight*

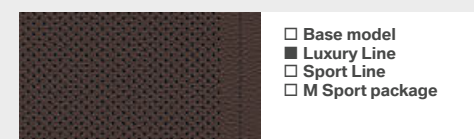

Base model
 Luxury Line
 Sport Line
 M Sport package

Leather 'Dakota' PDMY with perforations Mocha*



Base model
 Luxury Line
 Sport Line
 M Sport package

Leather 'Dakota' PDSW with perforations Black*

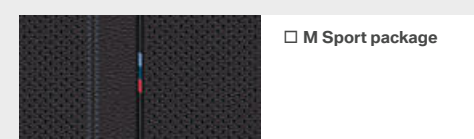

M Sport package

Leather 'Dakota' PDN4 with perforations Black, Blue highlight*

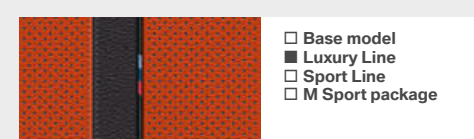

Base model
 Luxury Line
 Sport Line
 M Sport package

Leather Dakota PDFM with perforations Magma Red, Grey highlight*

INTERIOR TRIM FINISHERS

Available with

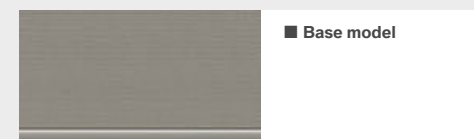

Base model

Interior trim finishers Quartz Silver matt, grained.



Base model
 Luxury Line
 Sport Line
 M Sport package

Interior trim finishers 'Illuminated Nice' with 'Hexanja' accent on the instrument panel and door panel.

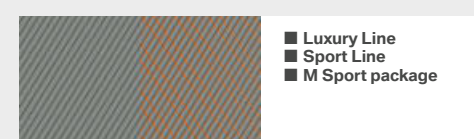

Luxury Line
 Sport Line
 M Sport package

Interior trim finishers 'Illuminated Boston' with 'Mesh' accent on the instrument panel and door panel.



Base model
 Luxury Line
 Sport Line
 M Sport package

Interior trim finishers 'Illuminated Brooklyn' with 'Triangle' accent on the instrument panel and door panel.

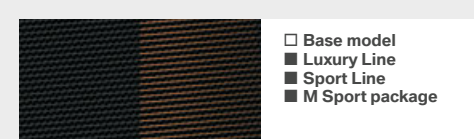

Base model
 Luxury Line
 Sport Line
 M Sport package

Interior trim finishers 'Illuminated Berlin' with 'High Matt' accent on the instrument panel and door panel.

*The availability of some equipment features and functions depends on engine variants or additional options. The market and production availability may vary. You can find detailed

¹ Available as standard with the M Sport package and M235i xDrive.
² Optionally also available with the M Sport package and M235i xDrive.

³ Exclusively available with the M Sport package and M235i xDrive.
⁴ Standard for M235i xDrive.

WHEELS AND TYRES.

Discover even more with the new BMW brochures app. Available now, for your smartphone and tablet.



■ 16" light alloy wheels Star-spoke style 517 Ferric Grey, 7J x 16, 205/55 R16 tyres.*



□ 17" light alloy wheels Multi-spoke style 546 Reflex Silver metallic, gloss-lathed, wheel size 7.5J x 17 with 225/45 R17 tyres.*



■ 17" light alloy wheels Multi-spoke style 547 Ferric Grey metallic, gloss-lathed, wheel size 7.5J x 17 with 225/45 R17 tyres.¹



□ 17" light alloy wheels Double-spoke style 548 Bicolour Orbit Grey metallic, gloss-lathed, 7.5J x 17 with 225/45 R17 tyres.*



■ 17" light alloy wheels Double-spoke style 549 Orbit Grey metallic, gloss-lathed, 7.5J x 17 with 225/45 R17 tyres.²



□ 18" light alloy wheels Multi-spoke style 488 Bicolour Orbit Grey metallic, gloss-lathed, wheel size 8J x 18 with 225/40 R18 tyres.



□ 18" M light alloy wheels V-spoke style 554 M Orbit Grey metallic, 8J x 18 with 225/40 R18 tyres.^{3,*}



■ 18" M light alloy wheels Double-spoke style 556 M Bicolour Cerium Grey matt, gloss-lathed, wheel size 8J x 18 with 225/40 R18 tyres.⁴



■ 18" M light alloy wheels Double-spoke style 819 M Bicolour Orbit Grey metallic, gloss-lathed, wheel size 8J x 18 with 225/40 R18 tyres.⁵



□ 19" M light alloy wheels V-spoke style 557 M Bicolour Cerium Grey metallic, wheel size 8J x 19 with 235/35 R19 tyres.^{4,*}



□ 19" M light alloy wheels Double-spoke style 552 M Bicolour Jet Black, gloss-lathed, wheel size 8J x 19 with 235/35 R19 tyres.^{3,*}

¹ Only available in conjunction with Luxury Line.

² Only available in conjunction with Sport Line.

³ Exclusively available in conjunction with M Sport package and M235i xDrive.

⁴ Exclusively available for M235i xDrive.

⁵ Exclusively available in conjunction with M Sport package.

*The availability of some equipment features and functions depends on engine variants or additional options. The market and production availability may vary. You can find detailed information about terms, standard and optional equipment at www.bmw.com or from your BMW Partner.

ORIGINAL BMW ACCESSORIES.

■ Standard equipment □ Optional equipment ○ Accessories



○ Wireless charging, any time and anywhere: Thanks to the BMW wireless charging station universal the smartphone can be charged comfortably and efficiently without a cable in the vehicle. The mobile phone is saved in a stable and safe way. Especially smart: The integrated powerbank can be removed and enables wireless charging outside the vehicle.



○ The perfectly fitted, anti-slip, durable mat with raised borders on all sides protects the luggage compartment from dirt and moisture. It is designed in Black.

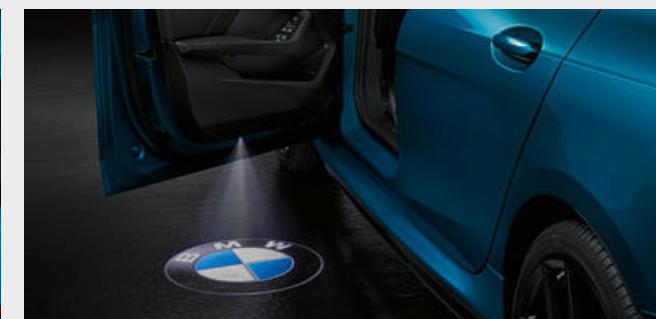

○ The LED door projectors are activated when the doors are opened. They project an image onto the ground next to the car using an interchangeable slide.



○ The perfectly fitted, durable all-weather floor mats with a raised border and elegant design protect the front footwell against moisture and dirt. They are black and feature a stainless steel inlay.



○ Sporty 18" M Performance forged wheels V-spoke style 554 M in Jet Black matt. TPMS summer complete wheel set, wheel size 8J x 18.

Discover the wide range of innovative solutions available for the exterior and interior, communication and information, and for transportation and the luggage compartment. Your BMW Partner is on hand to advise you on the whole range of Original BMW Accessories

and the BMW M Performance Parts product portfolio. For further information, please visit www.bmw.com

BMW 2 Series Gran Coupé		218i	M235i xDrive	220d
Weight				
Unladen EU (xDrive) ¹	kg	1425 [1450]	((1645))	[1580]
Max. permissible weight (xDrive)	kg	1885 [1905]	((2105))	[2050]
Permitted load (xDrive)	kg	535 [530]	((535))	[545]
Permitted trailer load, unbraked (xDrive) ²	kg	710 [725]	-	[750]
Permitted trailer load, braked, max. 12% gradient/max. 8% gradient (xDrive) ²	kg	1300/1300 [1300/1300]	-	[1300/1300]
Luggage capacity	l	430	430	430
BMW TwinPower Turbo engine³				
Cylinders/valves		3/4	4/4	4/4
Capacity	cm ³	1499	1998	1995
Max. output/engine speed	kW (hp)/ rpm	103 (140)/ 4600-6500	225 (306)/ 5000-6250	140 (190)/ 4000
Max. torque/engine speed	Nm/ rpm	220/ 1480-4200	450/ 1750-4500	400/ 1750-2500
Power transmission				
Type of drive		Front-wheel	All-wheel	Front-wheel
Standard transmission (xDrive)		6-speed manual	8-speed Steptronic Sport transmission	8-speed Steptronic transmission
Driving performance				
Top speed (xDrive)	km/h	215 [215]	((250)) ⁶	[235]
Acceleration 0-100 km/h (xDrive)	s	8.7 [8.7]	((4.9))[4.8 ⁶]	[7.5]
Consumption^{3,4} - All engines conform to the EU6 standard				
Combined (PHEV weighted) (xDrive)	l/100km	5.9-6.8 [6.1-7.0]	((7.6-8.3))	[4.9-5.6]
Exhaust emissions standard (type-certified)		EU6d-temp	EU6d-temp	EU6d-temp
Combined CO ₂ emissions (PHEV weighted) (xDrive)	g/km	134-153 [139-159]	((172-188))	[129-146]
Tank capacity, approx.	l	42	50	50
Wheels/tyres				
Tyre dimensions		205/55 R16 W	225/40 R18 Y	225/40 R17 Y
Wheel size		7Jx16	8Jx18	7.5Jx17
Material		Light alloy	Light alloy	Light alloy

The figures for performance, fuel consumption and CO₂ emissions refer to vehicles with standard transmission. Figures in [] are for vehicles with Steptronic transmission.

¹ The EC unladen weight refers to a vehicle with standard equipment and does not include any optional extras. The unladen weight includes a 90% full tank and a driver weight of 75 kg. Optional equipment may affect the weight of the vehicle, the payload and the top speed if the selected equipment has an impact on the vehicle's aerodynamics.

² The actual total weight of the trailer must not exceed the maximum trailer load, taking into account the maximum tow bar download.

³ Performance data of petrol engines apply to vehicles using RON 98 fuel. Fuel consumption data apply to vehicles using reference fuels in accordance with EU Regulation 2007/715. Unleaded RON 91 and higher with a maximum ethanol content of 10% (E10) may also be used. Depending on the model, BMW recommends RON 95 super unleaded petrol or RON 98 super plus unleaded petrol. Your local BMW Partner is available to provide further details.

⁴ The data for fuel consumption, CO₂ emissions and energy consumption are determined in accordance with the measurements processes as defined by European Regulation (EU) 715/2007 in the applicable version. Data refer to a vehicle with base-level equipment in Germany, and the ranges account for differences according to the selected wheel and tyre size and the optional equipment. For these vehicles, values other than those specified here may apply for the assessment of taxes and other vehicle-related charges that are (also) based on CO₂ emissions. Version 10/11/2019

⁵ Electronically limited.

⁶ Only available in conjunction with the optional M Performance package.

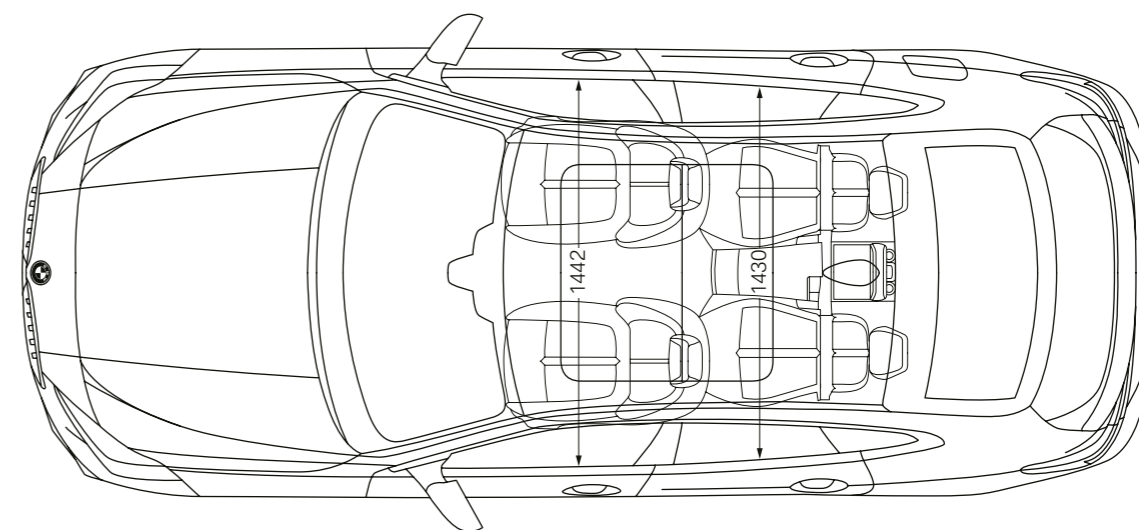
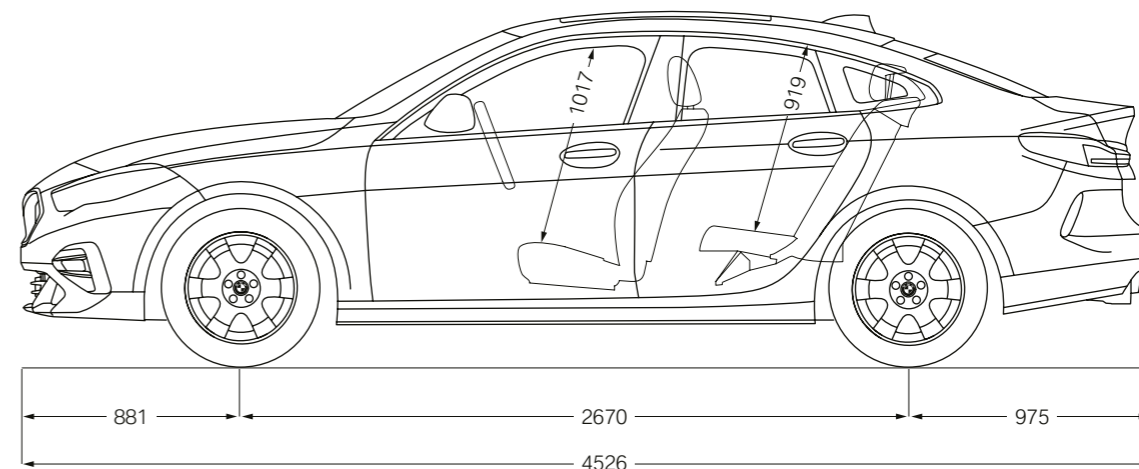
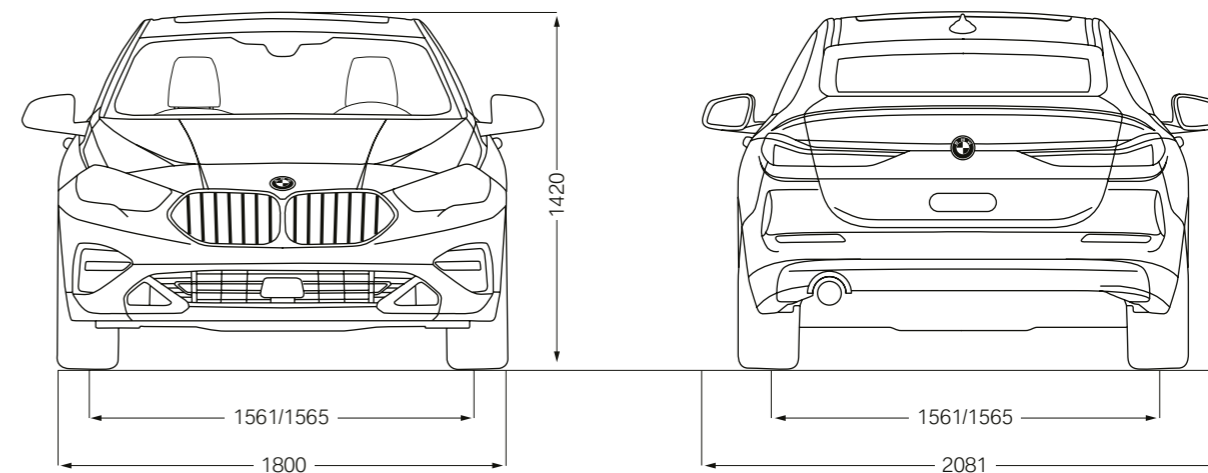

THE 3

THE X1

THE X6 M



THE X4

THE M4

THE 6

THE 2

THE 8

THE X7

THE 4

THE 1

THE Z4

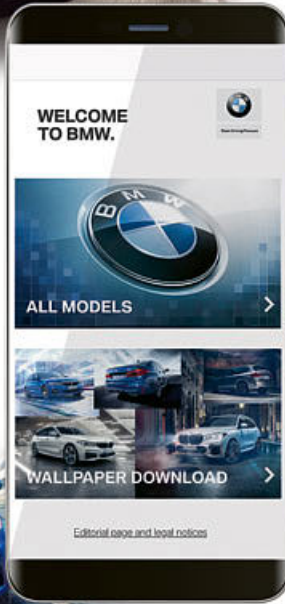

THE M3

THE 7

THE M5

THE 5

THE i8

THE X2



YOUR NEW SPEED DATING APP.

DOWNLOAD NOW THE BMW BROCHURES APP FROM YOUR APP STORE AND DISCOVER DRIVING PLEASURE!

BMW M235i xDRIVE:

M TwinPower Turbo 4-cylinder petrol engine, 225 kW (306 hp), 19" M light alloy wheels Double-spoke style 552 M Bicolour, gloss-lathed, exterior colour in Snapper Rocks Blue metallic, M Sport seats in leather 'Dakota' with perforations Black, interior trim finishers 'Illuminated Boston'.

The models illustrated in this medium show the equipment and configuration options (standard and optional) for vehicles produced by BMW AG for the German market. Alterations in standard and optional equipment and the configurations available for the different models, as described in this medium, may occur after 09/05/2019, the editorial deadline for this medium, or according to the specific requirements of other markets. Your local BMW Partner is available to provide further details. Subject to change in design and equipment.

Of course, each vehicle is designed for economical recycling after its long-running life. You can find more information regarding your end-of-life vehicle on our website www.bmw.com/recycling.

© BMW AG, Munich, Germany. Not to be reproduced wholly or in part without prior written permission of BMW AG, Munich.